**FAG****53307**

Axial deep groove ball bearing

Schaeffler ID:
0167158960000

Axial deep groove ball bearing 533, single direction, with spherical housing washer, steel sheet metal cage

Technical information

Main Dimensions & Performance Data

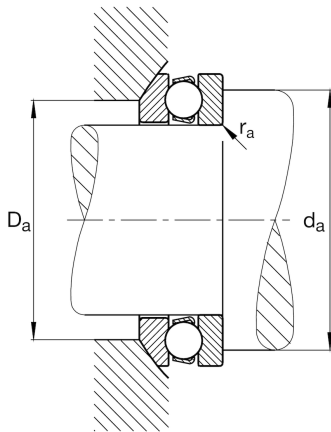
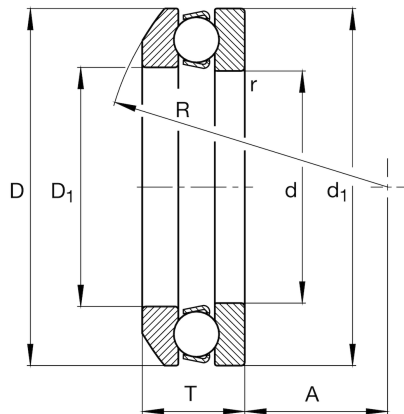

d	35 mm	Bore diameter
D	68 mm	Outside diameter
T	25.6 mm	Height
C_a	50,000 N	Basic dynamic load rating, axial
C_{0a}	89,000 N	Basic static load rating, axial
C_{ua}	4,050 N	Fatigue load limit, axial
n_G	4,850 1/min	Limiting speed
n_{gr}	8,200 1/min	Reference speed
	0.376 kg	Weight

Dimensions

r_{min}	1 mm	Minimum chamfer dimension
D_1	37 mm	Bore diameter housing washer
d_1	68 mm	Lip diameter shaft washer
R	56 mm	Radius spherical housing washer
A	24 mm	Distance of the center point
T_1	28 mm	Height with seat washer

Mounting dimensions

$d_{a min}$	55 mm	Minimum diameter shaft shoulder
$D_{a max}$	52 mm	Maximum diameter of housing shoulder
$r_{a max}$	1 mm	Maximum recess radius

Additional information

A	0.05	Minimum load factor
	U307	Seat washer

Temperature range

T_{min}	-30 °C	Operating temperature min.
T_{max}	150 °C	Operating temperature max.